

Metal Building Roof Curbs

Model: UMB-7

Metal Building Roof Curb with Loose Rib closures on plates for Under/Over Roof Installation.

Additional Options:

- 1.
- 2.
- 3.
- 4.

Standard Construction:

Two-piece curb with 18 ga. Galvalume steel shell and baseplate; 8" minimum height, water diverter plate, insulated, internal angle reinforcing with mitered corners and watertight welds; loose rib closures, prime painted after fabrication.

Roof Panel Manufacturer: _____ **Type:** _____

No. of Closures Under Panel: _____ **No. of Closures Over Panel:** _____
 (Uphill) (Downhill)

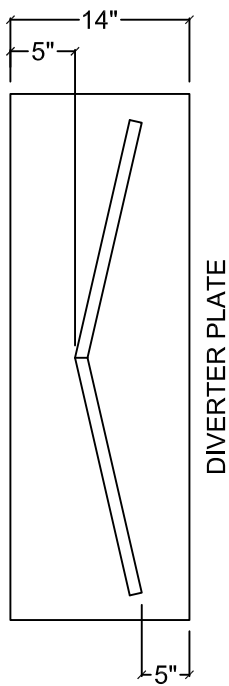
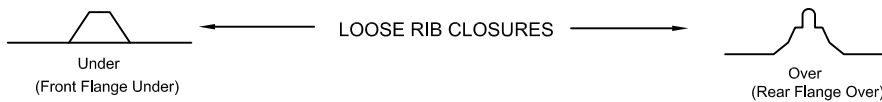

DIVERTER PLATE

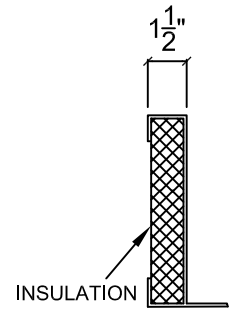
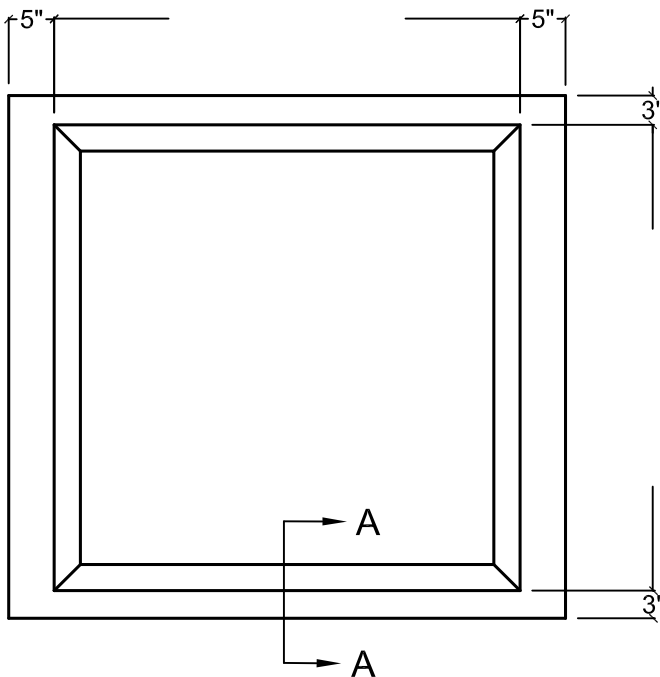

SECTION "A-A"
 UMB-7 INSULATED

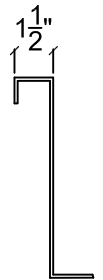

SECTION "A-A"
 UMB-7 NON-INSULATED

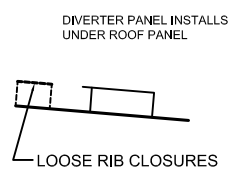

DIVERTER PANEL INSTALLS UNDER ROOF PANEL



No. Req'd.	I.D.	O.D.	DRAWN BY: SRB	DATE: 5-15-06	REV. DATE: 1-5-11
Tag- Description	H	L			
			REV. NO. 3	APPROVED BY: CBY	DWG. NO.: M-33