

**MODEL SFL-4**

**4" [102mm] FIXED STEEL LOUVER**

**STANDARD CONSTRUCTION:**

**FRAME:** 18 ga. galvanized steel, 4.13" [105mm] deep

**BLADES:** J style, 18 ga. galvanized steel, positioned at 45° angles on approximately 4" [102mm] centers.

**BIRDSCREEN:** 0.50" x 0.050" [12.70mm x 1.27mm] Expanded flattened alum. in removable frame. Screen is mounted on inside (rear)

**FINISH:** Mill Galvanized

**MINIMUM SIZE:** 8"w x 10"h [203mm x 254mm]

**MAXIMUM SECTION SIZE:** 96"w x 72"h [ 2438mm x 1829mm]  
Larger sizes made in multiple sections.

**OPTIONS:**

- Flanged Frame (1.5" [38mm] std.)
- Custom Flange (1", 2" , or 3" [25mm, 51mm, 76mm])
- Extended Sill
- Insect Screen (Other Screens Available, See Screen Page)
- Filter Racks (no screen)
- Security Bars
- Hinged Sub Frame
- Welded Construction
- Blank-off, Steel, non-insulated, no screen, non-removeable
- Blank-off, Steel, non-insulated, with bird screen or insect screen
- Blank-off, Steel, insulated double wall, with bird screen, removable
- Blank-off, Steel, insulated double wall, no screen, non-removeable
- Aluminum Construction
- 304 Stainless Steel Const.     316 Stainless Steel Const.

**AVAILABLE FINISHES:**

- Powder Polyester TGIC** (2 coats) baked on at 410°F [210° C], 2.5 to 3.5 mils Meets AAMA-2603 Standards
  - Powder Super durable polyester** (2 coats) baked on at 410°F [210° C], 2.5 to 3.5 mils Meets AAMA-2604-05 Standards
  - Acrylic baked enamel** (ACRA-BOND® ULTRA) by AkzoNobel baked on at 350°F [177° C], 0.8 to 1.2 mils dry Meets AAMA-2603 Standards
  - Kynar®** (ALUM\*A\*STAR®) 2 coats by AkzoNobel baked on at 450°F [222° C], 1.2 to 1.6 mils dry Meets AAMA-2604-05 Standards
  - Kynar 500®** or HYLAR® 5000 70% TRINAR® (2 coats) by AkzoNobel baked on at 450°F [222°C], 1.2 to 1.6 mils dry, Meets AAMA-2605-05 Standards
  - Kynar 500®** or HYLAR® 5000 (70% Tri-Escent II) (2 coats) by AkzoNobel, a superior finish to other metallic or anodized finishes. A blend of mica, ceramic, and inorganic pigments creates subtle yet dazzling design that goes beyond metallic color without the requirement of a clear coat. 14 standard colors - custom colors available. Baked on at 415°F [213° C], 1.4 to 1.8 mils dry, meets AAMA 2605-05.
  - Clear Anodize** 204 R-1 Class II (AA-C22A31)(0.4 to 0.7 mil)
  - Clear Anodize** 215 R-1 Class I (AA-C22A41)(>0.7 mil)
  - Integral Color Anodize** (AA-C22A42)(>0.7 mil)
- Clear coat available for all above finishes.
  - Hylar® 5000 is a registered trademark of Solvay Solexis, Inc.
  - Kynar® 500 is a registered trademark of Arkema.
  - ALUM\*A\*STAR® 50 and TRINAR® are registered trademarks of AkzoNobel
  - ACRA-BOND® ULTRA is a registered trademark of AkzoNobel

4.13"  
[105mm]

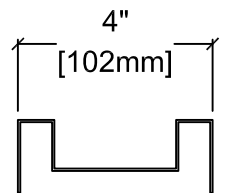
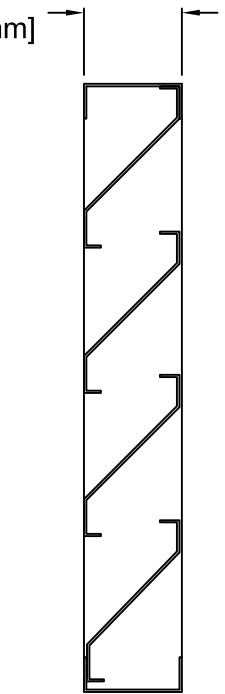
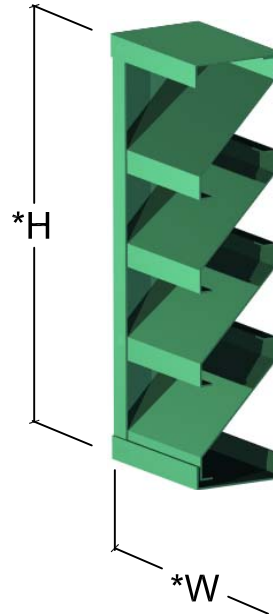

Typical Jamb

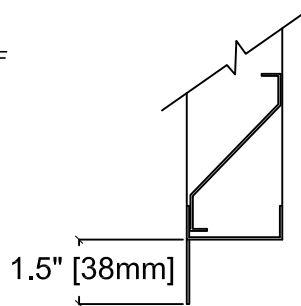

Optional Flange

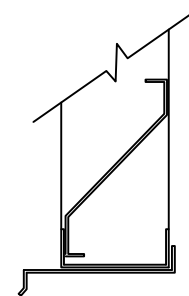

Optional Extended Sill

\*Width and Height dimensions are approximately 1/4" [6.35mm] under listed size.

Due to continuing research, United Enertech reserves the right to change specifications without notice.

		3005 South Hickory Street Chattanooga, Tennessee 37407 Tel: (423) 698-7715 Fax: (423) 698-6629 www.unitedenertech.com			
		<p><b>MODEL SFL-4 (4" [102mm] FIXED STEEL LOUVER)</b></p>			
DRAWN BY:	DATE:	REV. DATE:	REV. NO.	APPROVED BY:	DWG. NO.:
MHM	4-2-10	4-12-13	2	BGT	A-14

# SFL-4 LOUVER PERFORMANCE DATA

Model SFL-4 resistance to airflow varies depending on louver application (air intake or air exhaust). Free area velocities (shown) are higher than average velocity through the overall louver size. See louver selection information.

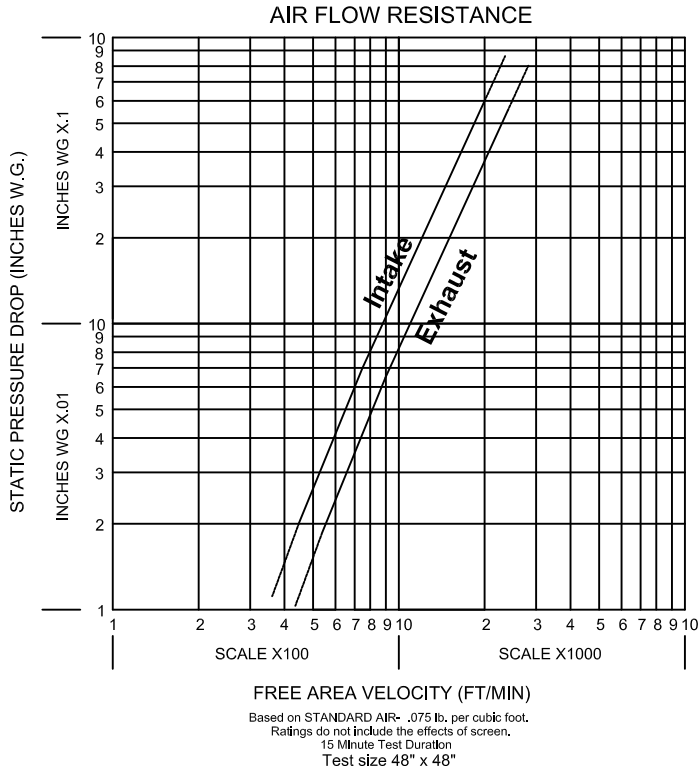

Beginning Point of water penetration for Model SFL-4 is **840 FPM**  
 FREE AREA VELOCITY AT .01 OZ. OF WATER

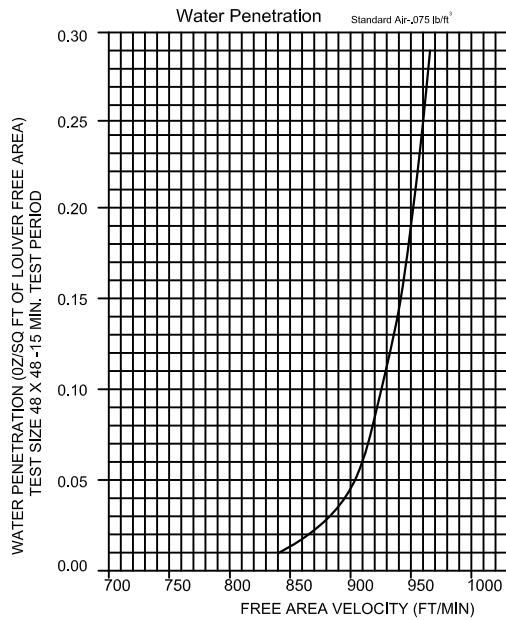

## LOUVER SELECTION AND APPLICATION

Application of any louver involves selecting an airflow velocity through the louver free area (free area velocity in fpm) that produces an acceptable pressure drop and minimizes carry through of normally encountered rain water.

No louver manufacturer warrants their louver to prevent water penetration under all possible combinations of wind and rain. Water penetration through SFL-4 begins at approximately 840 FPM free area velocity. Intake air louver selection using free area velocity below 840 FPM is recommended. Louver selection involves the following two steps, and depending on air conditions, either step may come first.

### Select Free Area Velocity:

Using the Airflow Resistance Chart, select a free area velocity that produces an acceptable pressure drop with minimal water penetration. (Water penetration need not be considered when selecting exhaust louvers.)

### Determine Louver Free Area:

Using the free area velocity from the previous step and total CFM, determine Louver Free Area required. Using Louver Free Area Chart, select a louver with the required free area. If louver size is given, determine free area from chart and work backwards to determine maximum airflow. See examples below.

### Free Area Chart (square feet):

Louver Height Inches	Louver Width in Inches										Louver Height Inches
	8	12	18	24	30	36	42	48	54	60	
10	0.07	0.11	0.19	0.26	0.34	0.41	0.49	0.56	0.64	0.71	10
12	0.13	0.23	0.38	0.53	0.68	0.83	0.98	1.13	1.28	1.43	12
18	0.23	0.41	0.67	0.93	1.20	1.46	1.73	1.99	2.25	2.52	18
24	0.38	0.67	1.10	1.54	1.97	2.40	2.84	3.27	3.70	4.14	24
30	0.48	0.84	1.39	1.94	2.49	3.04	3.58	4.13	4.68	5.23	30
36	0.63	1.11	1.82	2.54	3.26	3.98	4.69	5.41	6.13	6.85	36
42	0.73	1.28	2.11	2.95	3.78	4.61	5.44	6.27	7.11	7.94	42
48	0.88	1.54	2.55	3.55	4.55	5.55	6.55	7.55	8.56	9.56	48
54	0.98	1.72	2.84	3.95	5.07	6.18	7.30	8.42	9.53	10.65	54
60	1.12	1.98	3.27	4.55	5.84	7.12	8.41	9.70	10.98	12.27	60
66	1.22	2.16	3.56	4.96	6.36	7.76	9.16	10.56	11.96	13.36	66
72	1.37	2.42	3.99	5.56	7.13	8.70	10.27	11.84	13.41	14.98	72
78	1.47	2.60	4.28	5.96	7.65	9.33	11.02	12.70	14.38	16.07	78
84	1.62	2.86	4.71	6.57	8.42	10.27	12.13	13.98	15.83	17.69	84
90	1.72	3.03	5.00	6.97	8.94	10.91	12.87	14.84	16.81	18.78	90
96	1.87	3.30	5.43	7.57	9.71	11.85	13.98	16.12	18.26	20.40	96